

PROFINET

Future-proof communication network



» Open standard

» Media redundancy

» Easy configuration

PROFINET - Open Industrial Ethernet standard for automation

As a leading and innovative global supplier of industrial automation systems, Omron delivers equipment for installations throughout the world.

Recognising that needs differ between users, applications and countries, Omron pursues an open-standards policy that has proved to be the key to success. This extends to networking and connectivity, where we are constantly increasing our scope. Omron played a pioneering role, e.g. in developing DeviceNet and CompoNet and in addition to offering a wide range of products for CIP-based networks we actively support PROFIBUS-DP, by far the world's most popular system.

Networks, the next generation

Building on our experience with PROFIBUS, Omron is now a front runner in the support and development of PROFINET-IO, an open 'Industrial Ethernet' solution set to become Europe's next-generation field network. PROFINET-IO meets all requirements of industrial automation and provides the higher speeds necessary as intelligent devices become more complex. PROFINET is more adaptable than conventional bus systems, enabling users to optimize it for their own required functionality. Today, Omron is a leader in bringing PROFINET-compatible modules to the market.

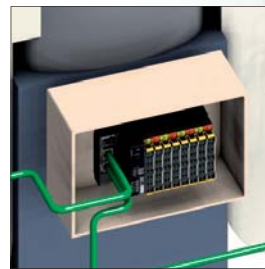

PROFINET cyclic data and standard UDP or TCP/IP data can share one cable.

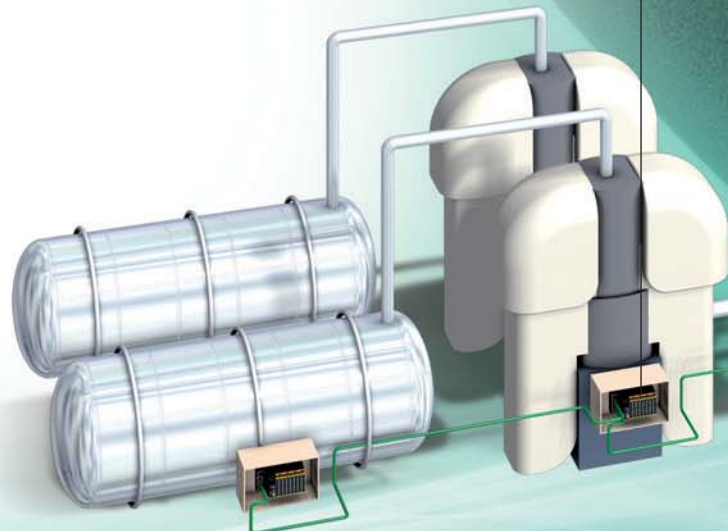
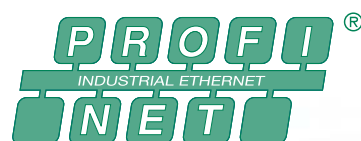

Built-in switches cut cost

Conventionally, Ethernet networks use a star topology, which requires extra hardware (switches) to interconnect devices. Omron's SmartSlice PROFINET-IO Unit gives the option of linking devices in the conventional line topology used with most field buses. No additional hardware is needed. Making use of field devices with an integrated switching function is a very efficient and cost-saving method that minimizes the bill of materials and saves on installation costs. It also facilitates easy system extension in the accustomed manner when the time arises.

Making Industrial Ethernet easy

PROFINET-IO offers many advantages for both system integrators and equipment/machinery manufacturers. Combining the ease of use of PROFIBUS-DP with a standard Ethernet physical layer, PROFINET-IO offers the increased speed, easier management of ever-increasing amounts of device data, and openness for integrating standard Ethernet data communication. PROFINET-IO has standardized functions for parameterization, diagnostics and alarms which are far more extensive than in conventional bus systems.

To manage this high functionality, OMRON provides FDT-based software tools, which make PROFINET-IO as easy to use as a conventional fieldbus system.



No need to install an industrial ethernet switch in every control cabinet.

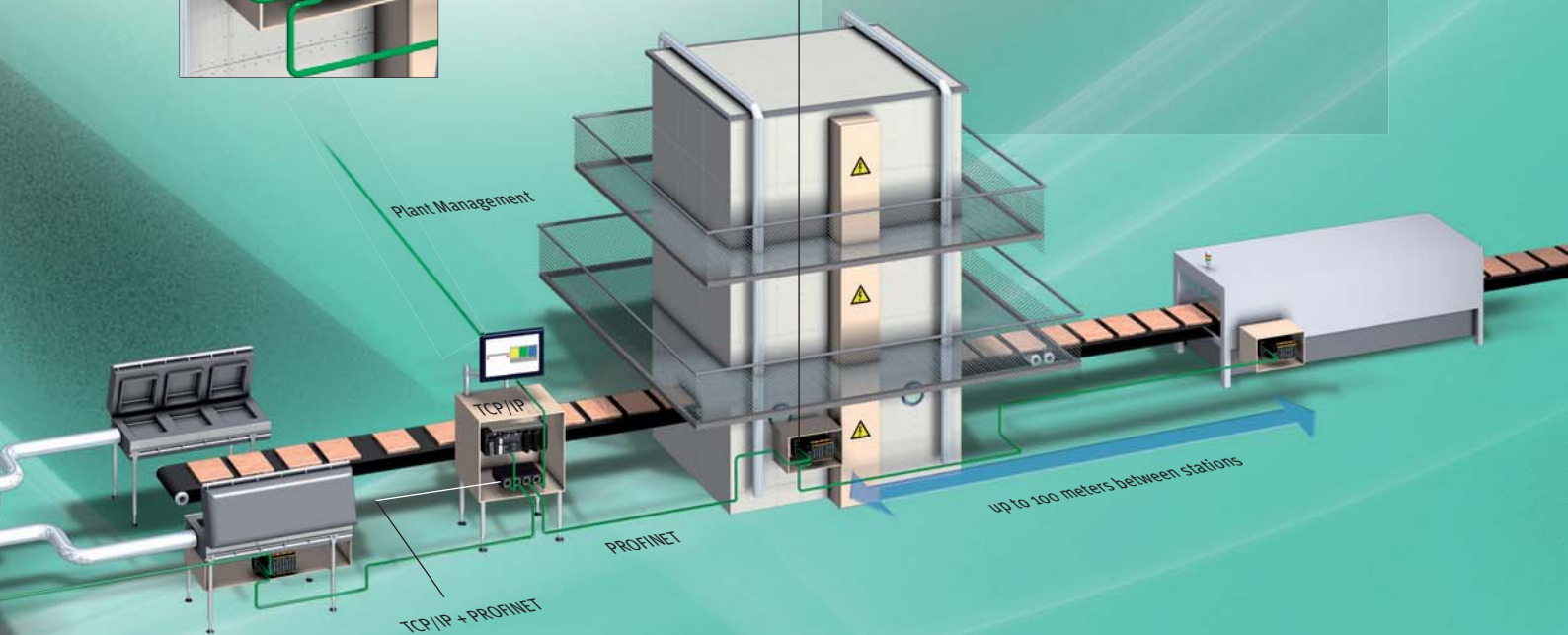

PROFINET-IO - benefit from tomorrow's advantages today



One switch as MRP manager controls the PROFINET-compliant redundant ring.

High availability by ring redundancy

Naturally, PROFINET is inherently reliable in its own right, but increased reliability of the network connection can be achieved by closing the line structure to form a ring. The advantage of a ring structure is that any single cable failure or malfunction in one device will not lead to a disruption in communication between other connected devices. This highly secure method requires one device in the ring to be a redundancy manager supporting the MRP (Media Redundancy Protocol) as prescribed in the PROFINET specification, to assure operation of all devices supporting ring redundancy.

MRP included

Omron's SmartSlice remote I/O stations support the MRP protocol as redundancy clients. They report the status of their communication connections to the MRP manager. In case of a connection failure, the MRP manager will activate the alternative communication path, so that all stations remain accessible. By including the SmartSlice stations as active members of the ring, the number of dedicated switches needed to build a redundancy ring is greatly reduced.



Conventional ring structure

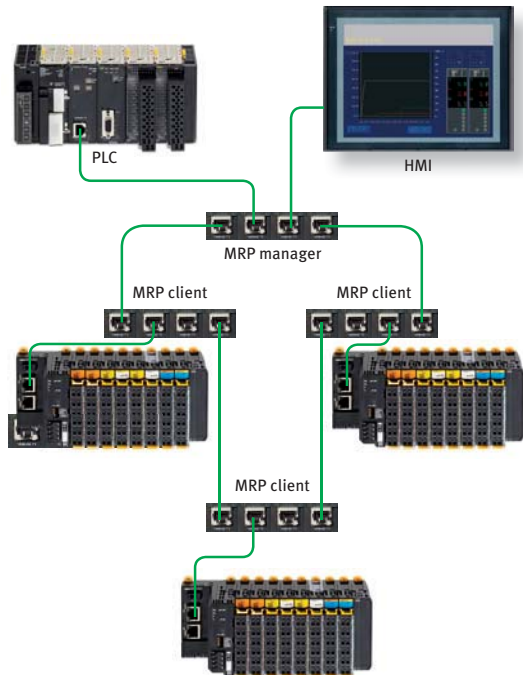

Ring redundancy with SmartSlice

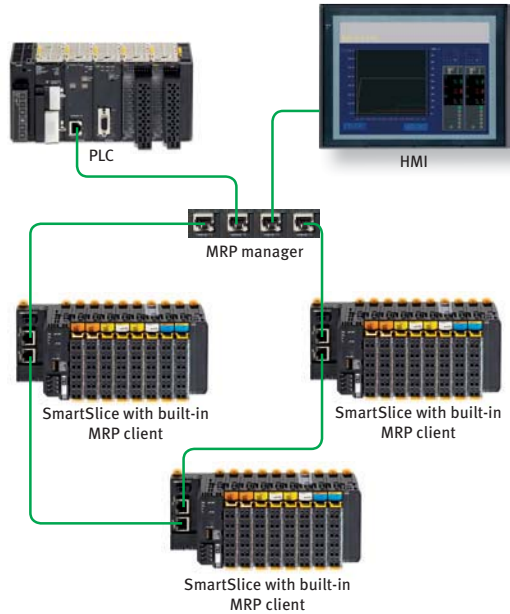

SmartSlice stations with built in MRP client; greatly reduce the installation costs.

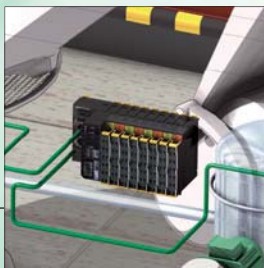

Built-in switch with MRP client function.

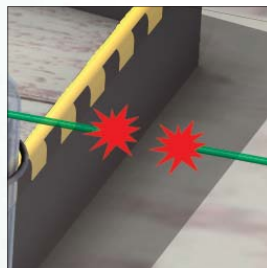

MRP clients report interruptions to the MRP manager, which activates the stand-by connection in milliseconds.

Case study: Marine applications

Control system design for ships is going through a rapid change towards fully integrated automation systems. Monitoring and control of e.g. power generation, HVAC, pumps and winches are made fully transparent, and remotely accessible. Controller- and network redundancy, and toolless unit replacement are key features of Omron's PROFINET solution to ensure maximum system availability.

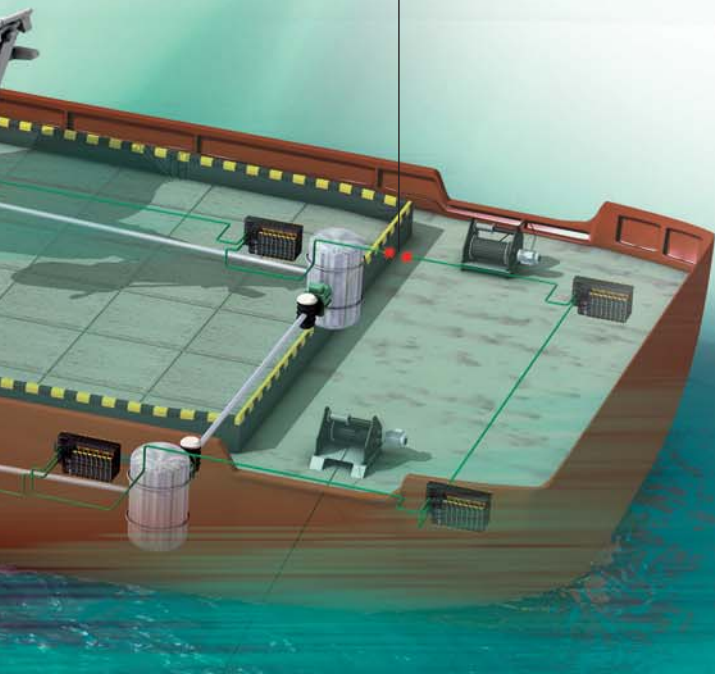

PROFINET - easy to set up, with open software tools



GSDML text file

DTM plugin

Omron products support PROFINET-IO for cyclic master-slave communication with 'soft' real-time characteristics, as required in general-purpose industrial automation. The most universal PROFINET variant, PROFINET-IO is similar to fieldbus communication and offers added flexibility while remaining easy to use.

One tool for all networks

Ease of use is the key to PROFINET's success. And if you currently use Omron's highly popular CX-One software, you already own the configuration tools. The network-independent FDT technology Omron already uses for its PROFIBUS configuration tool also supports PROFINET.

With PROFIBUS-DP interface units for all main product series Omron has already integrated PROFIBUS in its 'Smart Platform' solutions. Moreover, Omron's FDT-based configuration software, which is open to third-party devices,

offers full access to any parameter in any device, at any time.

FDT is Open Technology

An FDT program (Field Device Tool) is a network-independent framework that accepts product-specific plugins from any vendor provided it is FDT compliant. Called DTMs (Device Type Managers), these plugins provide a user interface for setting up and maintaining a device, and handle the communication over the network. This technology eliminates the need to learn how to use a new tool when changing bus systems and allows access to the device-specific features of each vendor's device via its own dedicated interface.

Any device that is not provided with a DTM can be configured using conventional text-based GSDML (XML) files.

PROFINET – Devices



PROFINET-IO controller CJ1W-PNT21

This module is designed for use with any CPU unit belonging to Omron's highly successful CJ1 series of programmable logic controllers. It uses a separate communication processor to guarantee reliable, high-level performance independent of the PLC program or its CPU speed. As it is transparent to Omron's own FINS communication protocol, the PROFINET IO controller also provides a communication channel so that legacy devices or existing software tools can be used to exchange data with the PLC CPU through the PROFINET controller.



FDT Group

The FDT Group is an open, independent collaboration of international companies dedicated to establishing FDT technology as an international standard within the automation industry. FDT technology standardizes the software interface between field devices and engineering systems. The key feature is its independence from the communication protocol and the software environment of either the device or the host system. FDT allows any device to be accessed from any host through any protocol. www.fdtgroup.org

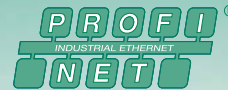

PROFIBUS & PROFINET International (PI)

PI is the international industrial communications community responsible for PROFINET and PROFIBUS, two of the most important technologies used in factory- and process automation today. Sales of PROFIBUS nodes has passed the 20 million mark and currently more than 1400 PI member companies around the world develop and supply products, services and solutions for industrial automation applications. The PI commitment to openness and standardization guarantees a wide choice of interchangeable products and stimulates innovation, ensuring best-in-class performance. And with 25 regional PI associations backed up by 24 PI Competence Centers and 7 PI Test Laboratories providing comprehensive assistance, a wide range of support is available, including local training. www.profinet.com



PROFINET-IO device GRT1-PNT

This communication interface for Omron's SmartSlice remote I/O system allows up to 64 SmartSlice units to be mounted per station. SmartSlice has built-in intelligence that helps users to reduce engineering time by autonomously monitoring machine status and performance to help schedule preventive maintenance. The PROFINET-IO device has two external network connections to allow direct linking of multiple devices in a line structure. Built-in support for MRP (Medium Redundancy Protocol) allows these units to be installed as an integral part of a redundant ring topology. An optional dedicated memory end plate allows on-site unit replacement without the need to reconfigure settings. For more information: www.smartslice.info

OMRON EUROPE B.V. Wegalaan 67-69, NL-2132 JD, Hoofddorp, The Netherlands. Tel: +31 (0) 23 568 13 00 Fax: +31 (0) 23 568 13 88 www.industrial.omron.eu

Austria

Tel: +43 (0) 2236 377 800
www.industrial.omron.at

Belgium

Tel: +32 (0) 2 466 24 80
www.industrial.omron.be

Czech Republic

Tel: +420 234 602 602
www.industrial.omron.cz

Denmark

Tel: +45 43 44 00 11
www.industrial.omron.dk

Finland

Tel: +358 (0) 207 464 200
www.industrial.omron.fi

France

Tel: +33 (0) 1 56 63 70 00
www.industrial.omron.fr

Germany

Tel: +49 (0) 2173 680 00
www.industrial.omron.de

Hungary

Tel: +36 1 399 30 50
www.industrial.omron.hu

Italy

Tel: +39 02 326 81
www.industrial.omron.it

Middle East & Africa

Tel: +31 (0) 23 568 11 00
www.industrial.omron.eu

Netherlands

Tel: +31 (0) 23 568 11 00
www.industrial.omron.nl

Norway

Tel: +47 (0) 22 65 75 00
www.industrial.omron.no

Poland

Tel: +48 (0) 22 645 78 60
www.industrial.omron.pl

Portugal

Tel: +351 21 942 94 00
www.industrial.omron.pt

Russia

Tel: +7 495 648 94 50
www.industrial.omron.ru

Spain

Tel: +34 913 777 900
www.industrial.omron.es

Sweden

Tel: +46 (0) 8 632 35 00
www.industrial.omron.se

Switzerland

Tel: +41 (0) 41 748 13 13
www.industrial.omron.ch

Turkey

Tel: +90 216 474 00 40
www.industrial.omron.com.tr

United Kingdom

Tel: +44 (0) 870 752 08 61
www.industrial.omron.co.uk

More Omron representatives
www.industrial.omron.eu

Authorised Distributor:

Control Systems

• Programmable logic controllers • Human-machine interfaces • Remote I/O

Motion & Drives

• Motion controllers • Servo systems • Inverters

Control Components

• Temperature controllers • Power supplies • Timers • Counters • Programmable relays
• Digital panel indicators • Electromechanical relays • Monitoring products • Solid-state relays
• Limit switches • Pushbutton switches • Low voltage switch gear

Sensing & Safety

• Photoelectric sensors • Inductive sensors • Capacitive & pressure sensors • Cable connectors
• Displacement & width-measuring sensors • Vision systems • Safety networks • Safety sensors
• Safety units/relay units • Safety door/guard lock switches