

Solid-state timer H3RN

Ultra-slim Timer for G2R Relay Socket

- Pin configuration compatible with G2R Relay and mounts to the P2R/P2RF Socket.
- Standard multiple time ranges and multiple operating modes.
- Conforms to EN61812-1 and IEC60664-1 4 kV/2 for Low Voltage, and EMC Directives.

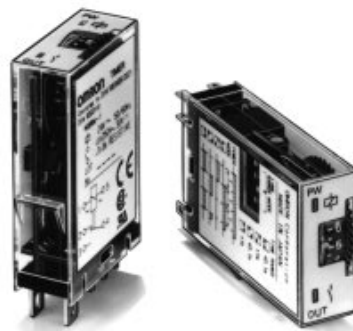

Model Number Structure

Model Number Legend

H3RN-□□
1 2

1. Output

- 1: SPDT
- 2: DPST-NO

2. Time Range

- None: Short-time range (0.1 s to 10 min)
- 1: Long-time range (0.1 min to 10 hrs)

Ordering Information

List of Models

Supply voltage	Time-limit contact	Short-time range model (0.1 s to 10 min)	Long-time range model (0.1 min to 10 h)
24 VAC; 12, 24 VDC	SPDT	H3RN-1	H3RN-11
	DPST-NO	H3RN-2	H3RN-21

Note: Specify both the model number and supply voltage when ordering.
Example: H3RN-1 24 VAC

□ Supply voltage

Accessories (Order Separately)

Connecting Socket

Timer	Track mounting/Front connecting socket	Back connecting socket
H3RN-1/-11	P2RF-05-E	P2R-057P
H3RN-2/-21	P2RF-08-E	P2R-087P

Specifications

■ Ratings

Item	H3RN-1/H3RN-2	H3RN-11/H3RN-21
Time ranges	0.1 s to 10 min (1 s, 10 s, 1 min, or 10 min max. selectable)	0.1 min to 10 h (1 min, 10 min, 1 h, or 10 hrs max. selectable)
Rated supply voltage	24 VAC (50/60 Hz); 12, 24 VDC	
Pin type	Plug-in	
Operating mode	ON-delay, interval, flicker OFF-start, or flicker-ON start selectable by DIP switch	
Operating voltage range	85% to 110% of rated supply voltage (12 VDC: 90% to 110% of rated supply voltage) (see note)	
Reset voltage	10% max. of rated supply voltage	
Power consumption	24 VAC: Relay ON: approx. 0.8 VA (0.6 W) at 24 VAC, 60 Hz Relay OFF: approx. 0.6 VA (0.4 W) at 24 VAC, 60 Hz 12 VDC: Relay ON: approx. 0.5 W at 12 VDC Relay OFF: approx. 0.2 W at 12 VDC 24 VDC: Relay ON: approx. 0.6 W at 24 VDC Relay OFF: approx. 0.3 W at 24 VDC	
Control outputs	3 A at 250 VAC, resistive load ($\cos\phi = 1$) (G6B-2□14P-FD-US used) The minimum applicable load is 10 mA at 5 VDC (P reference value).	

Note: When using the H3RN in any place where the ambient temperature is more than 50°C, supply 90% to 110% of the rated voltages (12 VDC: 95% to 110% of the rated voltage).

■ Characteristics

Item	H3RN-1/H3RN-2	H3RN-11/H3RN-21
Accuracy of operating time	±1% FS max. (1 s range: ±1%±10 ms max.)	
Setting error	±15%±50 ms FS max.	
Reset time	Min. power-opening time: 12, 24 VDC: 0.1 s max. (including halfway reset) 24 VAC: 0.5 s max. (including halfway reset)	
Influence of voltage	±2% FS max.	
Influence of temperature	±2% FS max.	
Insulation resistance	100 MΩ min. (at 500 VDC)	
Dielectric strength	2,000 VAC, 50/60 Hz for 1 min (between operating circuit and control output, or contacts of different poles) 1,000 VAC, 50/60 Hz for 1 min (between non-continuous contacts)	
Vibration resistance	Destruction: 10 to 55 Hz, 0.75-mm single amplitude for 1 h each in 3 directions Malfunction: 10 to 55 Hz, 0.5-mm single amplitude for 10 min each in 3 directions	
Shock resistance	Destruction: 300 m/s ² Malfunction: 100 m/s ²	
Ambient temperature	Operating: -10°C to 55°C (with no icing) Storage: -25°C to 65°C (with no icing)	
Ambient humidity	Operating: 35% to 85%	
Life expectancy	Mechanical: 10,000,000 operations min. (under no load at 1,800 operations/h) Electrical: 100,000 operations min. (3 A at 250 VAC, resistive load at 1,800 operations/h)	
Impulse withstand voltage	Between power terminals: 1 kV	
Noise immunity	±1.5 kV, square-wave noise by noise simulator (pulse width: 100 ns/1 μs, 1-ns rise)	
Static immunity	Destruction: 8 kV Malfunction: 4 kV	
Degree of protection	IP40 (Terminal screw sections are excluded.)	
Weight	Approx. 18 g	

Item	H3RN-1/H3RN-2	H3RN-11/H3RN-21
EMC	(EMI) Emission Enclosure: Emission AC Mains: (EMS) Immunity ESD: Immunity RF-interference from AM Radio Waves: Immunity Burst: Immunity Surge:	EN61812-1 EN55011 Group 1 class A EN55011 Group 1 class A EN61812-1 EN61000-4-2: 6 kV contact discharge (level 3) 8 kV air discharge (level 3) IEC61000-4-3:10 V/m (80 MHz to 1 GHz) (level 3) EN61000-4-4: 2 kV power-line (level 3) 2 kV I/O signal-line (level 4) IEC51000-4-5: 1 kV line to line (level 3) 2 kV line to ground (level 3)
Approved standards	UL508, CSA C22.2 No. 14 Conforms to EN61812-1, IEC60664-1 4 kV/2. Output category according to IEC60947-5-1.	

Connections

■ Connection

H3RN-1/H3RN-11

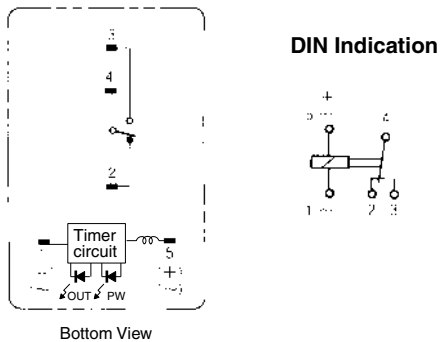

H3RN-2/H3RN-21

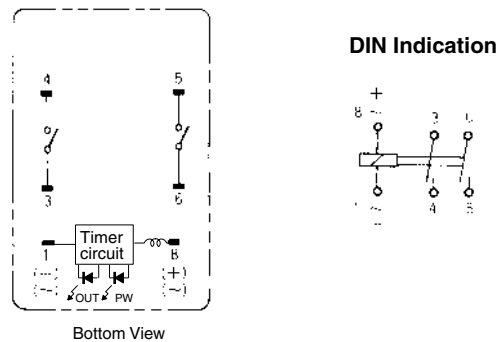

Pulse Operation

A pulse output for a certain period can be obtained with a random external input signal.

Use the H3RN in interval mode as shown in the following timing charts.

H3RN-2/H3RN-21

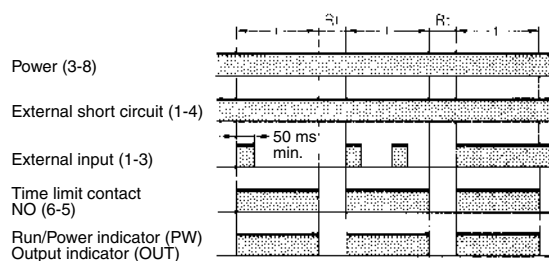
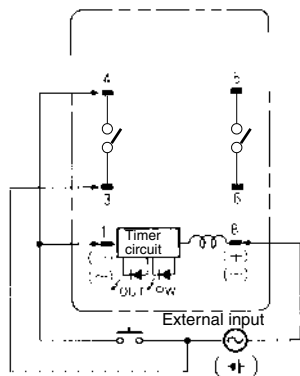

Note: t: Set time
Rt: Reset time

⚠ Caution

Be careful when connecting wires.

Mode	Terminals
Pulse operation	Power supply between 3 and 8 Short-circuit between 4 and 1 Input signal between 3 and 1
Operating mode; interval and all other modes	Power supply between 1 and 8

Operation

■ Timing Chart

Operating mode	Timing chart	
	H3RN-1/H3RN-11	H3RN-2/H3RN-21
ON-delay 		
Interval 		
Flicker OFF-start 		
Flicker ON-start 		

Note: t: Set time
 Rt: Reset time

■ DIP Switch Settings

The 1-s range and ON-delay mode for H3RN-1/-2, 1-min range and ON-delay mode for H3RN-11/-21 are factory-set before shipping.

Time Ranges

Model	Time range	Time setting range	Setting	Factory-set
H3RN-1, H3RN-2	1 s	0.1 to 1 s		Yes
	10 s	1 to 10 s		No
	1 min	0.1 to 1 min		No
	10 min	1 to 10 min		No
H3RN-11, H3RN-21	1 min	0.1 to 1 min		Yes
	10 min	1 to 10 min		No
	1 h	0.1 to 1 h		No
	10 h	1 to 10 h		No

Note: The left two DIP switch pins are used to select the time ranges.

Operating Modes

Operating mode	Setting	Factory-set
ON-delay		Yes
Interval		No
Flicker OFF-start		No
Flicker ON-start		No

Note: The right two DIP switch pins are used to select the operating modes.

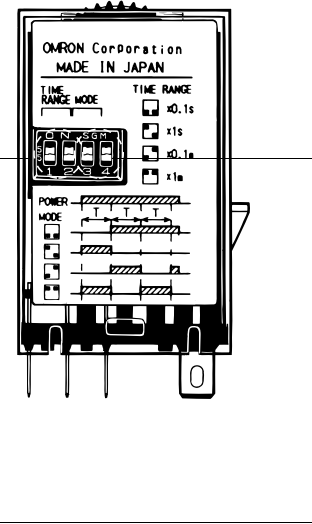

Nomenclature

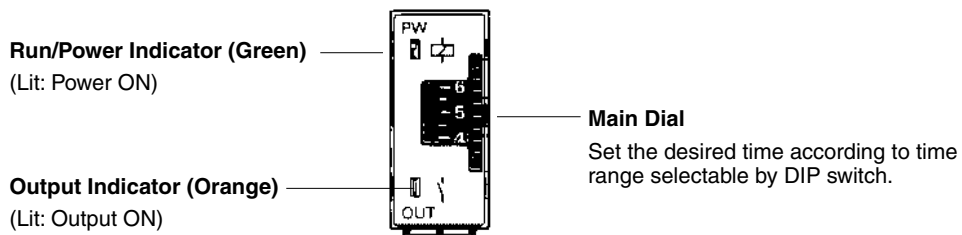

Dimensions

Note: All units are in millimeters unless otherwise indicated.

Timers

H3RN-1/H3RN-11 Front Mounting

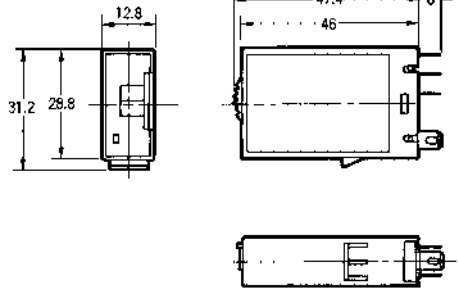
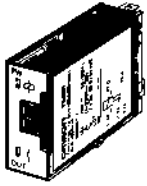

H3RN-2/H3RN-21 Front Mounting

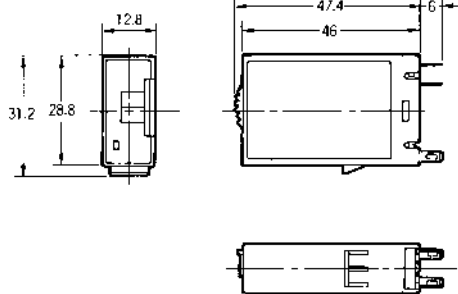
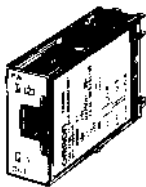

Mounting Height

Use the P2RF-□-E or P2R-□7P to mount the H3RN. When ordering any one of these sockets, replace "□" with "05" for SPDT or "08" for DPST-NO. The P2RF-□ cannot be used because the hook is a different shape.

P2RF-□-E

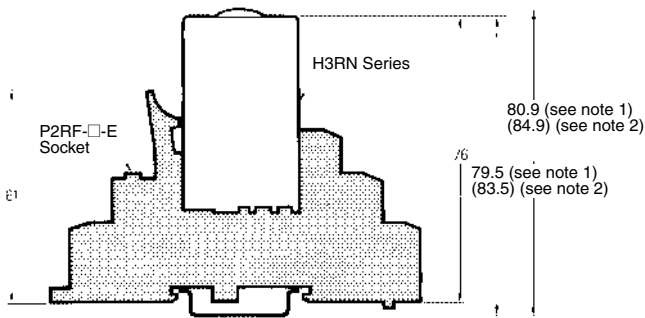

P2R-□7P

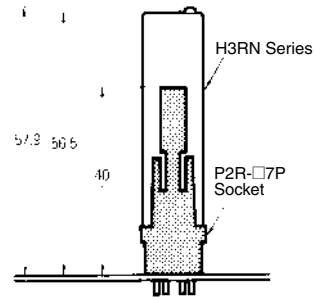

- Note:**
1. The value shown indicates the dimension for the P2RF-05-E with the PFP-□N Mounting Rail. The value is 71.5 mm when using the PFP-N□2.
 2. The value shown in parentheses indicates the dimension for the P2RF-08-E with the PFP-□N Mounting Rail. The value is 75.5 mm when using the PFP-N□2.

Precautions

Correct Use

When using the H3RN in any place where the ambient temperature is more than 50°C, supply 90% to 110% of the rated voltages (at 12 VDC: 95% to 110%).

Do not leave the H3RN in time-up condition for a long period of time (for example, more than one month in any place where the ambient temperature is high), otherwise the internal parts may become damaged. Therefore, the use of the H3RN with a relay as shown in the following circuit diagram is recommended.

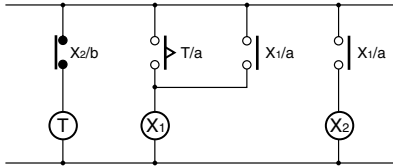

⊗ : Auxiliary relay such as G2R Relay

The H3RN must be disconnected from the socket when setting the DIP switch, otherwise the user may touch a terminal imposed with a high voltage and get an electric shock.

Do not connect the H3RN as shown in the following circuit diagram on the right hand side, otherwise the H3RN's internal contacts different from each other in polarity may become short-circuited.

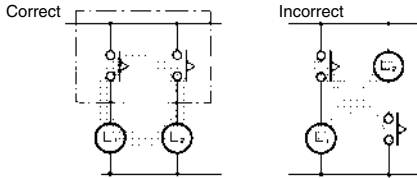

Use the following safety circuit when building a self-holding circuit with the H3RN and an auxiliary relay, such as a G2R Relay, in combination.

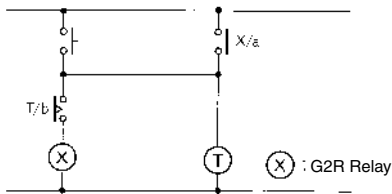

In the case of the above circuit, the H3RN will be in pulse operation. Therefore, if the circuit shown on page 101 is used, no auxiliary relay will be required.

Do not use the SPDT contact in a circuit which may cause short-circuiting at three points (otherwise, short-circuiting of the power supply may occur) because the SPDT contact of H3RN-1/-11 is composed of an SPST-NC contact.

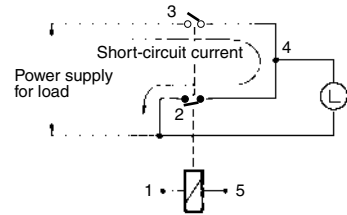

Do not set to the minimum setting in the flicker modes, otherwise the contact may be damaged.

Do not use the H3RN in places where there is excessive dust, corrosive gas, or direct sunlight.

Make sure that there is a space of 3 mm or more between any H3RN Models next to each other. (When using the P2RF-□-E Socket, a space of 3 mm or more will be secured.) If a space of 3 mm or more is not secured, the ambient temperature must be less than 50°C.

The internal parts may become damaged if a supply voltage other than the rated ones is imposed on the H3RN.

Precautions for EN61812-1 Conformance

The H3RN as a built-in timer conforms to EN61812-1 provided that the following conditions are satisfied.

Handling

Do not touch the DIP switch while power is supplied to the H3RN.

Before dismantling the H3RN from the socket, make sure that no voltage is imposed on any terminal of the H3RN.

Wiring

Basic insulation is ensured between the H3RN's operating circuit and control output.

Basic insulation: Overvoltage category III, pollution degree 2 (with a clearance of 3.0 mm and a creepage distance of 3.0 mm at 240 VAC)

The clearance from the edge of the P2R-087P Socket to internal, current-carrying metal parts is 1.3 mm. Position the H3RN to provide the necessary clearance for the voltage used.

When using the P2RF-□-E or P2R-057P Socket, basic insulation is ensured in the mounted condition for a voltage of 250 VAC max.

ALL DIMENSIONS SHOWN ARE IN MILLIMETERS.
To convert millimeters into inches, multiply by 0.03937. To convert grams into ounces, multiply by 0.03527.