

Safety-door Switch D4BS

The Special Operation Key Activates a Direct Opening Mechanism to Open the Contacts and Shut Off Control Circuits when Protective Doors Are Opened on Machine Tools or Other Equipment

- Conforms to EN (TÜV) standards corresponding to the CE marking.
- Approved by UL, CSA, BIA, and SUVA standards.
- The Switch contact is opened by a direct opening mechanism (NC contacts only) when the protective cover is opened. The EN-approved direct opening mechanism is indicated by ⊕ on the Switch.
- Malfunctions and false operation prevented by special Operation Key.
- Wide temperature range specifications: -40 to 80°C.
- Degree of protection of the switch box: IP67 (EN60947-5-1).
- Series includes models with gold-plated contacts for handling the microload range.

Note: Be sure to read the "Precautions for All Safety Door Switches" on page A-2.



Safety Door
Switches
D4BS

Model Number Structure

Model Number Legend

Switch

D4BS - S

1 2 3

1. Conduit

- 1: PG13.5 (1 conduit)
- 2: G1/2 (1 conduit)
- 3: 1/2-14NPT (1 conduit)
- 5: PG13.5 (3-conduit)
- 6: G1/2 (3-conduit)
- 7: 1/2-14NPT (3-conduit)

2. Built-in Switch

- 5: 1NC/1NO (slow-action)
- 6: 1NC/NO (slow-action), gold-plated contacts
- A: 2NC (slow-action)
- B: 2NC (slow-action), gold-plated contacts

3. Head Mounting Direction

- F: Four mounting directions possible (front-side mounting at shipping)

Operation Key

D4BS - K

1

1. Operation Key Type

- 1: Horizontal mounting
- 2: Vertical mounting
- 3: Adjustable mounting (Horizontal)

Note: Do not order the head and Switch separately. (The Operation Key, however, must be ordered separately.)



Ordering Information

List of Models

Switches (Operation Keys are sold separately.)

Type	Mounting direction		Conduit size	1NC/1NO (Slow-action)	2NC (Slow-action)
1-conduit	Front-side mounting		Pg13.5	D4BS-15FS	D4BS-1AFS
			G1/2	D4BS-25FS	D4BS-2AFS
			1/2-14NPT	D4BS-35FS	D4BS-3AFS
3-conduit	Front-side mounting		Pg13.5	D4BS-55FS	D4BS-5AFS
			G1/2	D4BS-65FS	D4BS-6AFS
			1/2-14NPT	D4BS-75FS	D4BS-7AFS

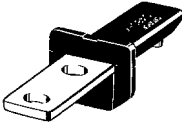
Operation Keys (Order Separately)

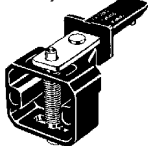
Type	Model
Horizontal mounting 	D4BS-K1
Vertical mounting 	D4BS-K2
Adjustable mounting (Horizontal) 	D4BS-K3

Safety Door Switches

D4BS

Specifications

Standards and EC Directives

- Conforms to the following EC Directives:
 - Machinery Directive
 - Low Voltage Directive
 - EN50041
 - EN1088

Approved Standards

Agency	Standard	File No.
TÜV Rheinland	EN60947-5-1	R9351022 (Direct opening: approved) 
UL	UL508	E76675
CSA	CSA C22.2 No. 14	LR45746
BIA	GS-ET-15	9303323
SUVA	SUVA	E6187.d
CQC (CCC)	GB14048.5	2003010305073833

Approved Standard Ratings

TÜV (EN60947-5-1), CCC (GB14048.5)

Utilization category	AC-15
Rated operating current (I_e)	2 A
Rated operating voltage (U_e)	400 V

Note: Use a 10-A fuse type a gI or gG that conforms to IEC60269 as a short-circuit protection device.

UL/CSA (UL508, CSA C22.2 No. 14)

A600

Rated voltage	Carry current	Current		Volt-amperes	
		Make	Break	Make	Break
120 VAC	10 A	60 A	6 A	7,200 VA	720 VA
240 VAC		30 A	3 A		
480 VAC		15 A	1.5 A		
600 VAC		12 A	1.2 A		

■ Characteristics

Degree of protection (see note 2)	IP67 (EN60947-5-1) (This applies for the Switch only. The degree of protection for the key hole is IP00.)
Durability (see note 3)	Mechanical: 1,000,000 operations min. Electrical: 500,000 operations min. (10 A at 250 VAC, resistive load)
Operating speed	0.1 m/s to 0.5 m/s
Operating frequency	30 operations/min max.
Rated frequency	50/60 Hz
Contact gap	2 x 2 mm min.
Direct opening force (see note 4)	19.61 N min. (EN60947-5-1)
Direct opening travel (see note 4)	20 mm min. (EN60947-5-1)
Full stroke	23 mm min.
Insulation resistance	100 MΩ min. (at 500 VDC) between terminals of same or different polarity, between each terminal and ground, and between each terminal and non-current-carrying metal part
Contact resistance	25 mΩ max. (initial value)
Rated insulation voltage (U _i)	600 V (EN60947-5-1)
Conventional enclosed thermal current (I _{the})	20 A (EN60947-5-1)
Dielectric strength (U _{imp})	Impulse dielectric strength (U _{imp}) 4 kV (EN60947-5-1) between terminals of same or different polarity, between current-carrying metal parts and ground, and between each terminal and non-current-carrying metal part
Switching overvoltage	1,500 V max. (EN60947-5-1)
Conditional short-circuit current	100 A (EN60947-5-1)
Pollution degree (operating environment)	3 (EN60947-5-1)
Insulation class	Class I (with ground terminal)
Vibration resistance	Malfunction: 10 to 500 Hz, 0.65-mm single amplitude
Shock resistance	Destruction: 1,000 m/s ² min. (IEC68-2-27) Malfunction: 300 m/s ² min. (IEC68-2-27)
Ambient temperature	Operating: -40°C to 80°C (with no icing)
Ambient humidity	Operating: 95% max.
Weight	Approx. 285 g (in the case of D4BS-15FS)

Note: 1. The above values are initial values.

- The degree of protection is tested using the method specified by the standard (EN60947-5-1). Confirm that sealing properties are sufficient for the operating conditions and environment beforehand. Although the switch box is protected from dust, oil, or water penetration, do not use the D4BS in places where dust, oil, water, or chemicals may enter through the key hole on the head, otherwise Switch damage or malfunctioning may occur.
- The durability is for an ambient temperature of 5°C to 35°C and an ambient humidity of 40% to 70%. Contact your OMRON sales representative for more detailed information on other operating environments.
- These figures are minimum requirements for safe operation.

Connections

■ Contact Form (Diagrams Show State with Key Inserted)

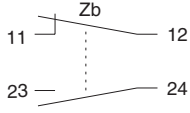
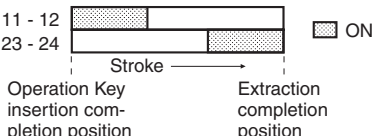
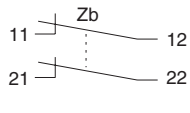
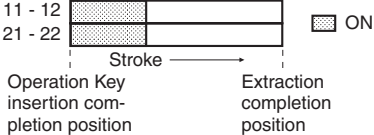
Model	Contact form	Operating pattern	Remarks
D4BS-□5□S	1NC/1NO 		<p>Only NC contact 11-12 has an approved direct opening mechanism. (→)</p> <p>Terminals 11-12 and 23-24 can be used as unlike poles.</p>
D4BS-□A□S	2NC 		<p>NC contacts 11-12 and 21-22 have an approved direct opening mechanism. (→)</p> <p>Terminals 11-12 and 21-22 can be used as unlike poles.</p>

Note: The terminal numbers are in accordance with EN50013, and the contact symbols are in accordance with IEC60947-5-1.

Safety Door Switches
D4BS

Nomenclature

Safety Door Switches
D4BS

Operation Key

D4BS's exclusive-use Operation Key is provided to assure accurate switching operation.

Set Zone Mark

A triangular Set Zone Mark makes it easy to adjust the operating position when inserting the Operation Key.

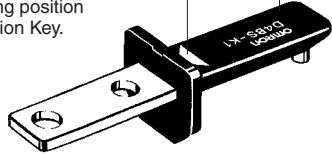

Built-in Switch

A shearing force contact separating mechanism (NC contact) is employed, which positively pulls apart the contacts from each other by using shearing force if any abnormality such as contact welding should occur in the contact area.

There is a difference in level between the NC and NO terminal, which assures easy wiring.

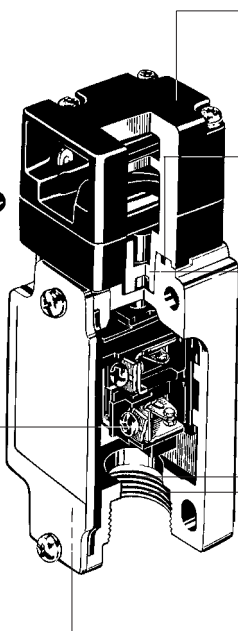

Head

The switch head is coated with easy-to-see red paint. The mounting direction of the switch head can be varied to any of the four directions.

Seal Ring (NBR)

Oil Seal (NBR)

The operation plunger employs an oil seal, with which the switch box meets the requirements of IP67 (the sealing capability of the Operation Key's insertion mouth is IP00).

Seal Packing (NBR)

Conduit Opening

Ground Terminal Screw

A ground terminal is provided to improve safety. (Built into the Unit.)

Box Size	1-conduit box	3-conduit box
Pg13.5	Yes	Yes
G1/2	Yes	Yes
1/2-14NPT	Yes	Yes

Dimensions

Switches

1-conduit

- D4BS-1□□S
- D4BS-2□□S
- D4BS-3□□S

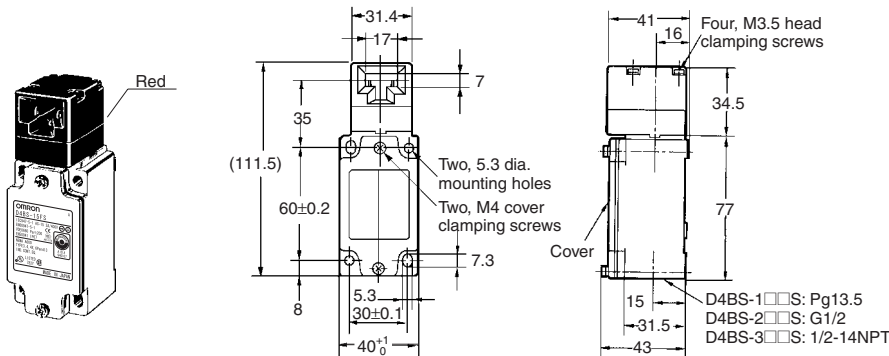

Operating characteristics	D4BS-1□□S D4BS-2□□S D4BS-3□□S
Key insertion force	19.61 N max.
Key extraction force	19.61 N max.
Pretravel (PT)	10±5 mm
Direct opening force	19.61 N min.
Direct opening stroke	20 mm min.

3-conduit

- D4BS-5□□S
- D4BS-6□□S
- D4BS-7□□S

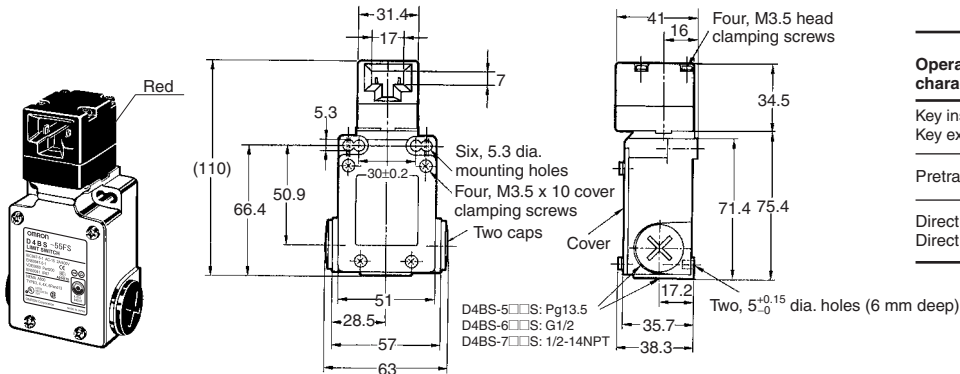

Operating characteristics	D4BS-5□□S D4BS-6□□S D4BS-7□□S
Key insertion force	19.61 N max.
Key extraction force	19.61 N max.
Pretravel (PT)	10±5 mm
Direct opening force	19.61 N min.
Direct opening stroke	20 mm min.

- Note:**
- All units are in millimeters unless otherwise indicated.
 - Unless otherwise specified, a tolerance of ±0.4 mm applies to all dimensions.
 - There are fluctuations in the contact ON/OFF timing for 2NC contacts. Confirm performance before application.
 - The conduit thread varies with the model as follows:

Conduit thread	Model
Pg 13.5	D4BS-1□□S, D4BS-5□□S
G1/2	D4BS-2□□S, D4BS-6□□S
1/2-14NPT	D4BS-3□□S, D4BS-7□□S

Operation Keys

D4BS-K1

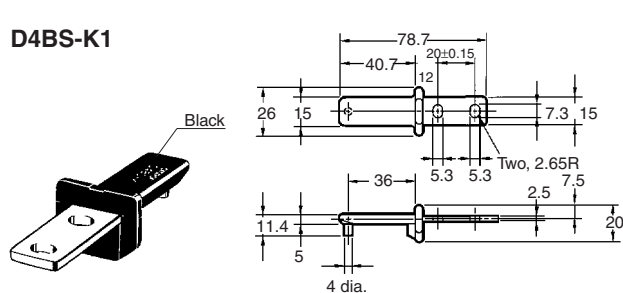

D4BS-K2

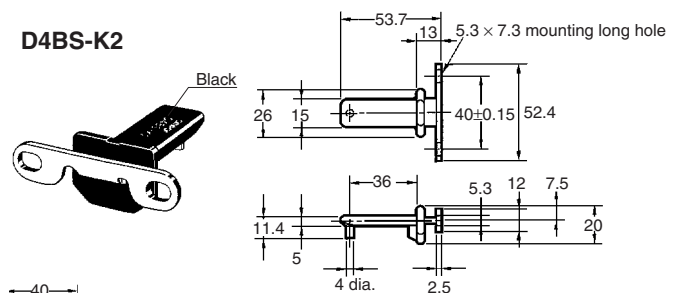

D4BS-K3

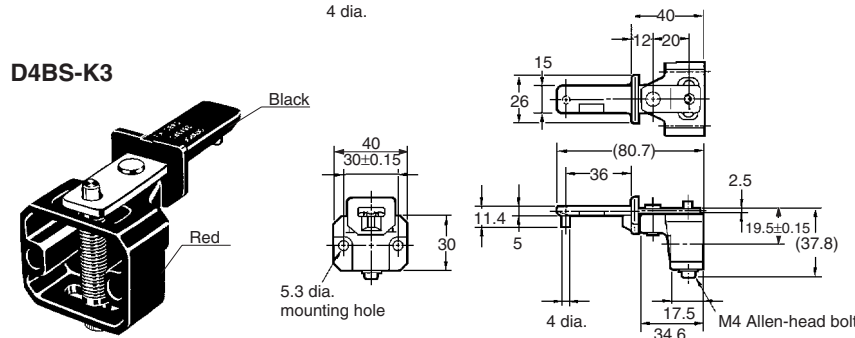

With Operation Key Inserted

Horizontal Mounting

- D4BS-1□□S +D4BS-K1
- D4BS-2□□S +D4BS-K1
- D4BS-3□□S +D4BS-K1

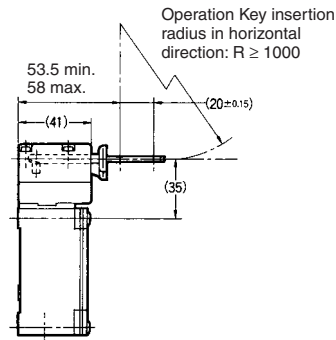
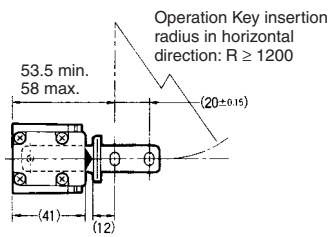
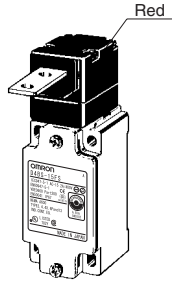

Vertical Mounting

- D4BS-1□□S +D4BS-K2
- D4BS-2□□S +D4BS-K2
- D4BS-3□□S +D4BS-K2

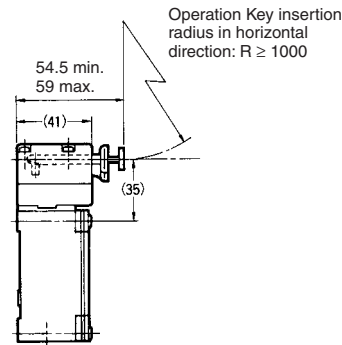
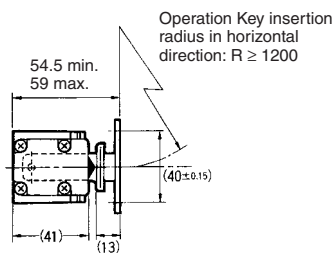
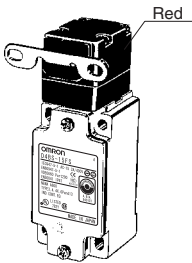

Adjustable Mounting (Horizontal)

- D4BS-1□□S +D4BS-K3
- D4BS-2□□S +D4BS-K3
- D4BS-3□□S +D4BS-K3

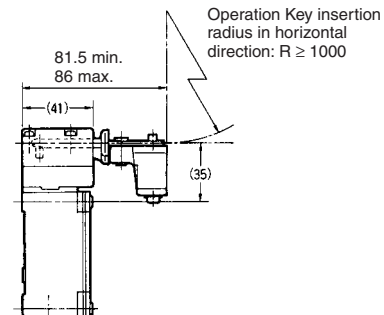
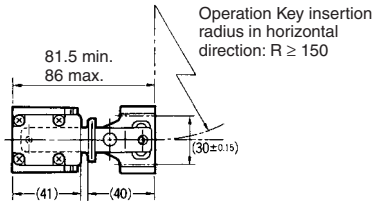
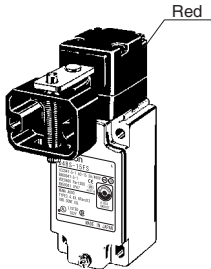

Note: "R" is the Operation Key insertion radius.

Note: Unless otherwise specified, a tolerance of ± 0.4 mm applies to all dimensions.

Safety Door Switches
D4BS

Safety Precautions

Refer to the "Precautions for All Switches" on page I-2 and "Precautions for All Safety Door Switches" on page A-2.

Precautions for Safe Use

- Do not use the Switch submersed in oil or water or in locations continuously subject to splashes of oil or water. Doing so may result in oil or water entering the Switch. (The IP67 degree of protection of the Switch specifies the amount of water penetration after the Switch is submersed in water for a certain period of time.)
- Although the Switch body is protected from the ingress of dust or water, avoid the ingress of foreign substance through the key hole on the head. Otherwise, accelerated wear or breaking may result.
- Always attach the cover after completing wiring and before using the Switch. Electric shock may occur if the Switch is used without the cover attached.

Precautions for Correct Use

Tightening Torque

Loose screws may result in malfunction. Tighten the screws to the specified torques.

Type	Torque
M3.5 terminal screw (including ground terminal screw)	0.59 to 0.78 N-m
Cover mounting screw (See note 1.)	1.18 to 1.37 N-m
Head mounting screw	0.78 to 0.98 N-m
M5 body mounting screw (See note 2.)	4.90 to 5.88 N-m
Operation Key mounting screw	2.35 to 2.75 N-m
Connector	1.77 to 2.16 N-m
Cap screw	1.27 to 1.67 N-m

- Note:** 1. Apply a torque of 0.78 to 0.88 N-m if the D4BS is a three-conduit model.
 2. Apply a torque of 4.90 to 5.88 N-m for an Allen-head bolt. For a pan head screw, apply a torque of 2.35 to 2.75 N-m.

Mounting Dimensions (M5)

Standard Model

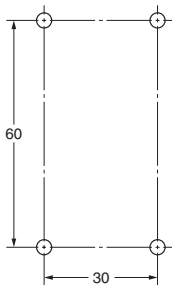

Three-conduit Model

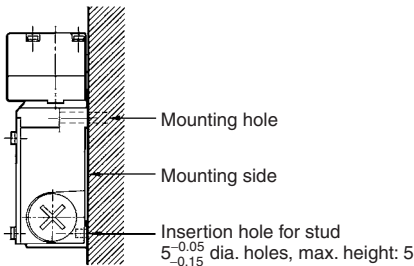
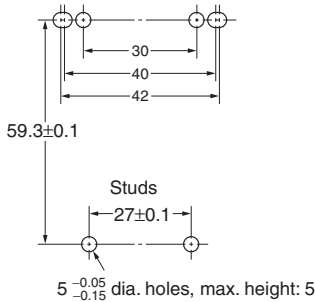

The D4BS can be mounted more securely by adding two studs, each of which is 5 mm maximum in height and $5_{-0.05}^{-0.15}$ mm in diameter as shown below.

Operation Key Mounting Dimensions

Horizontal Mounting

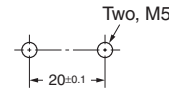

Vertical Mounting

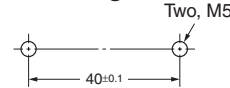

Adjustable Mounting (Horizontal)

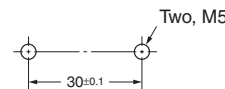

For safety, use screws that cannot be easily removed or a similar means to prevent the Switch and Operation Key from being easily removed.

Operation Key

Make sure that the Operation Key can be inserted properly with a tolerance of ± 0.5 mm in the upward, downward, left, or right direction, otherwise the D4BS may soon become damaged.

Observe the specified insertion radius for the Operation Key and insert it in a direction perpendicular to the key hole.

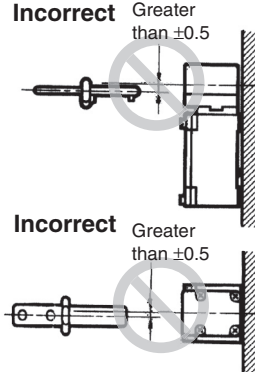

Changes in Head Mounting Direction

By removing the screws on the four corners of the head, the head can be reset in any of four directions. The head direction can be changed with or without the Operation Key inserted in the head. Make sure that no foreign materials enter through the head and that the head is tightened securely within the proper torque range.

Stopper Installation

Do not use a Switch as a stopper. Be sure to install a stopper as shown in the following illustration when mounting the Switch so that the base of the Operation Key does not strike the Head.

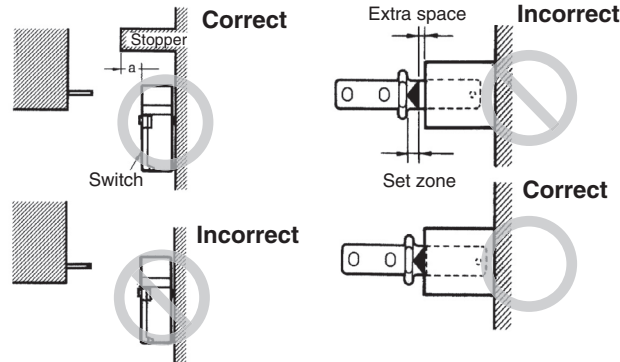

Refer to *Dimensions* for the mounting dimensions of the Operation Key and mount the Operation Key correctly. The Operation Key will soon become damaged or worn out if it is not mounted correctly.

Wiring

Do not connect the lead wires directly to the terminals. Connect the lead wires through insulation tubes and M3.5 crimp terminals. Tighten each terminal screw within the proper torque range.

The proper lead wire is AWG20 to AWG14 (0.5 to 2.5 mm²) in size.

dz dia.: 3.7
 D dia.: 4.5
 B: 7.0
 L: 20.2
 F: 7.7
 l: 9.0 (mm)

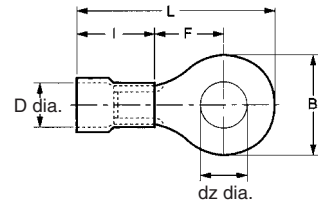

Wire using the methods shown below so that the crimp terminals are not caught on the case or cover. Otherwise it may not be possible to mount the cover completely and malfunctions may occur.

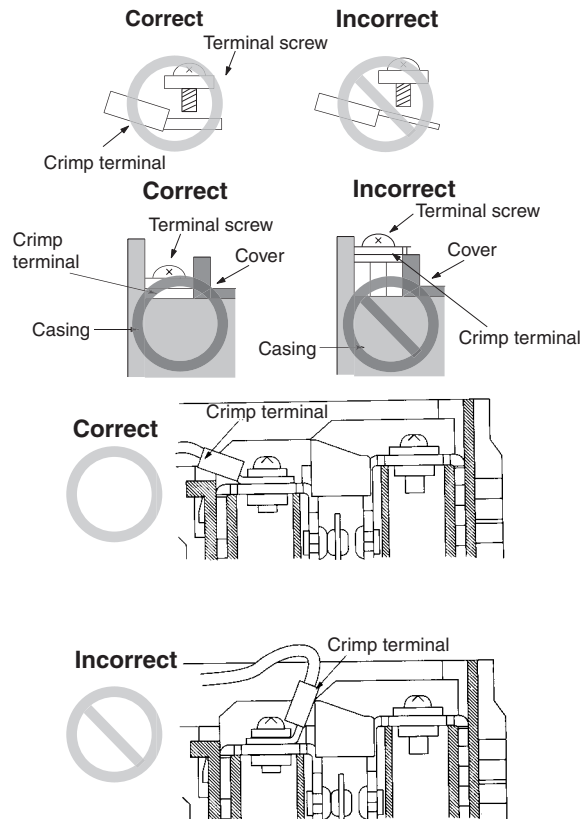

Conduit Opening

Tighten the connector to a suitable torque. Excessive tightening torque may damage the casing.

When using 1/2-14NPT conduits, apply sealing tape between the connector and conduit opening to maintain the degree of protection (IP67) of the Switch. If using a Pg13.5 conduit, use an ABS-08 Pg13.5 connector or an ABS-12 Pg13.5 connector (manufactured by Nippon Flex).

Use a connector (SC Series, sold separately) suitable for the outer diameter of the cable.

When wiring a 3-conduit model, securely tighten the cap screw provided for unused conduit openings.

ALL DIMENSIONS SHOWN ARE IN MILLIMETERS.
 To convert millimeters into inches, multiply by 0.03937. To convert grams into ounces, multiply by 0.03527.