

Key-type Selector Switch A22K

Install in 22-dia. or 25-dia. Panel Cutout

- Easy mounting and removal of Switch Unit.
- Increase wiring efficiency with three-row mounting of Switch Blocks.
- Finger protection mechanism on Switch Unit provided as a standard feature.
- Use 25-dia. ring to install in 25-dia. panel cutouts.
- Mounted using either open-type (fork-type) or closed-type (round-type) crimp terminals.
- IP65 oil resistance
- EN60947-5-1
- UL and cUL approved (File No. E41515).



Model Number Structure

Model Number Legend

Completely Assembled

Shipped as a set which includes the Selector and Switch.

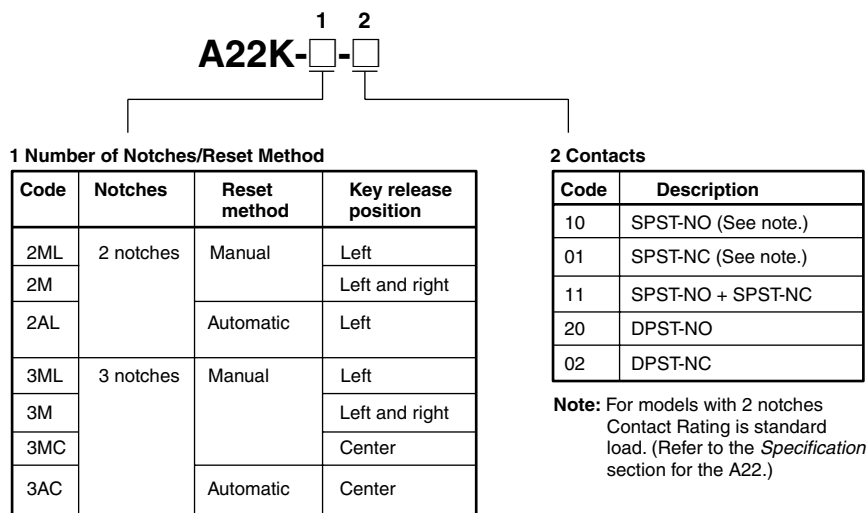

Subassembled

The Selector, Lamp, or Switch can be ordered separately. Use them in combination for models that are not available as assembled Units. These can also be used as inventory for maintenance parts.

1. Selector

A22K-¹
□

1 Number of Notches/Reset Method

Code	Notches	Reset method	Key release position
2ML	2 notches	Manual	Left
2M			Left and right
2AL		Automatic	Left
3ML	3 notches	Manual	Left
3M			Left and right
3MC			Center
3AC		Automatic	Center

2. Switch

Non-lighted

A22-¹
□
M











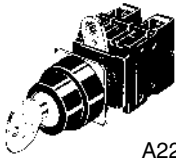

















1 Contacts

Code	Description
10	SPST-NO (2-notch models only)
01	SPST-NC (2-notch models only)
11	SPST-NO + SPST-NC
20	DPST-NO
02	DPST-NC

Ordering Information

■ List of Models

Ordering as a Set

Appearance	Number of notches	Reset method	Output	Key release position	Model	Color of Selector			
Key-type Selector Switch  A22K	2 notches	Manual 	SPST-NO		A22K-2ML-10	Black			
					A22K-2M-10				
			SPST-NC		A22K-2ML-01				
					A22K-2M-01				
			SPST-NO + SPST-NC		A22K-2ML-11				
					A22K-2M-11				
			DPST-NO		A22K-2ML-20				
					A22K-2M-20				
			DPST-NC		A22K-2ML-02				
					A22K-2M-02				
			Automatic 		Automatic		SPST-NO		A22K-2AL-10
									SPST-NC
	SPST-NO + SPST-NC	A22K-2AL-11							
		DPST-NO				A22K-2AL-20			
	DPST-NC	A22K-2AL-02							
	3 notches	Manual 				Manual	SPST-NO + SPST-NC		
				A22K-3M-11					
				A22K-3MC-11					
			DPST-NO		A22K-3ML-20				
					A22K-3M-20				
					A22K-3MC-20				
			DPST-NC		A22K-3ML-02				
					A22K-3M-02				
					A22K-3MC-02				
Automatic 				Automatic	SPST-NO + SPST-NC			A22K-3AC-11	
					DPST-NO			A22K-3AC-20	
					DPST-NC			A22K-3AC-02	

Note: Two Keys are provided.

Ordering Individually

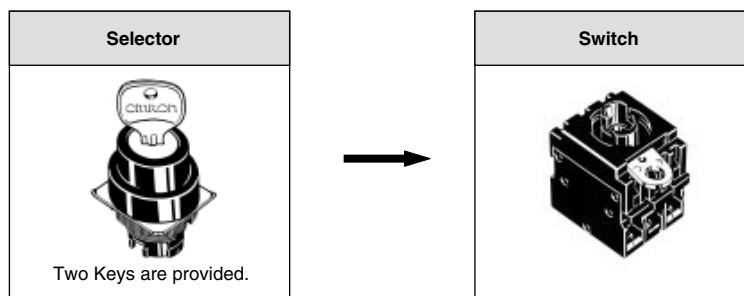

Selector

(Color: Only Black is available)

Appearance	Number of notches	Reset method	Key release position	Model
	2 notches	Manual		A22K-2ML
				A22K-2M
	3 notches	Automatic		A22K-2AL
				A22K-3ML
				A22K-3M
				A22K-3MC
	Automatic		A22K-3AC	

Note: Two keys are provided.

Switch

Appearance	Classification		Model	
	Lighted	Socket (without voltage-reduction circuit)	SPST-NO	A22-10M
			SPST-NC	A22-01M
			SPST-NO + SPST-NC	A22-11M
			DPST-NO	A22-20M
			DPST-NC	A22-02M

Note: DPST-NO + DPST-NC combination is also possible.

Accessories

Appearance	Model
	A22K-K

Note: Two keys are provided.

Accessories

The A22K uses the same accessories as the A22. Refer to the relevant information in the corresponding section for the A22.

Specifications

With the exception of the following items, the specifications are the same as for the A22. Refer to the relevant information in the *Specifications* section for the A22.

■ Operation Angle

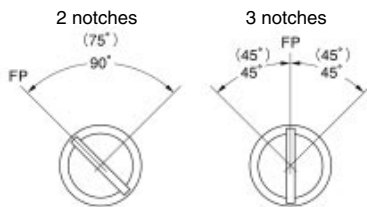

Note: 1. The angles in parentheses are for automatic-reset models.
 2. FP: Free position

■ Contacts

2-notch Type

Knob position	SPST-NO	SPST-NC	SPST-NO + SPST-NC	DPST-NO	DPST-NC

3-notch Type

Knob position	SPST-NO + SPST-NC	DPST-NO	DPST-NC

Nomenclature

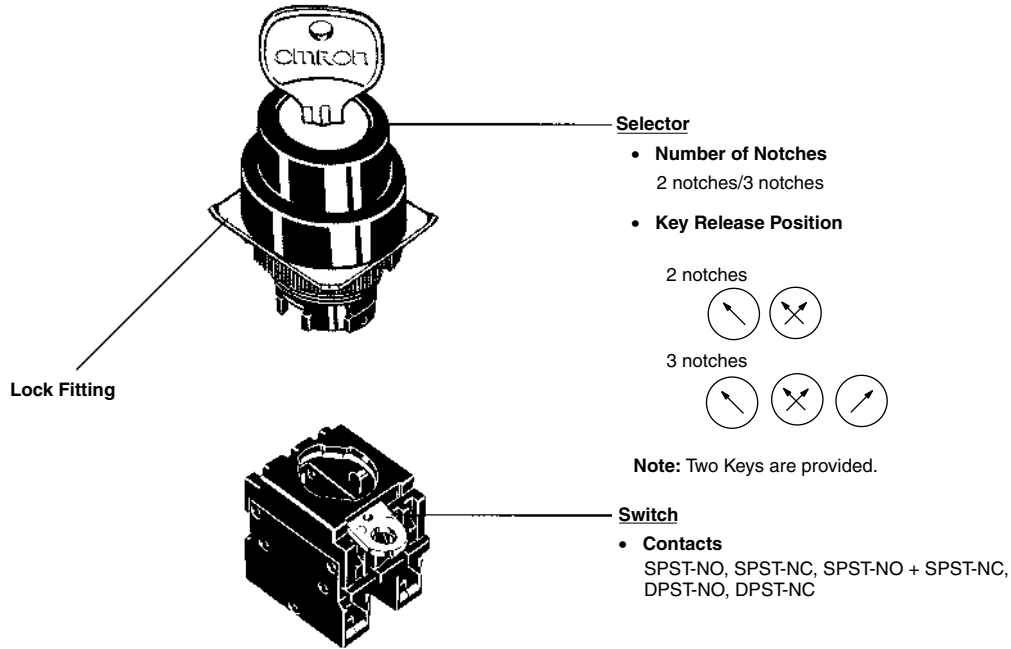

Dimensions

Note: All units are in millimeters unless otherwise indicated.

■ Key-type Selector Switch

A22K

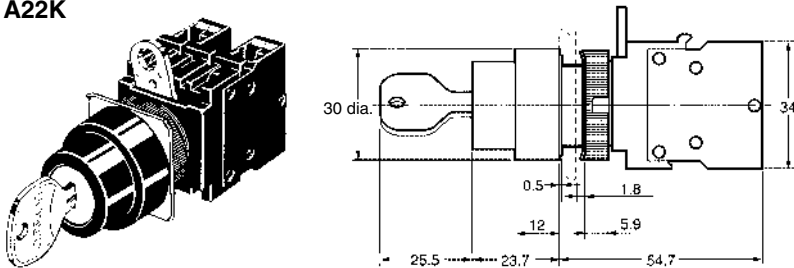

■ Accessories

The A22K uses the same accessories as the A22. Refer to the relevant information in the corresponding section for the A22.

■ Terminal Arrangement (Bottom View)

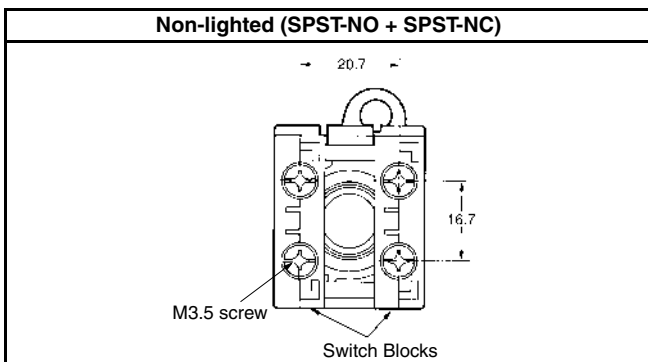

Terminal Connection

Type	Terminal connection
Non-lighted	<p>Bottom view</p>

Note: The above terminal connection diagrams are examples for SPST-NO + SPST-NC.

Panel Cutouts (Top View)

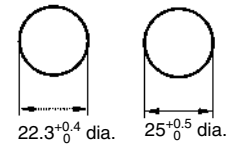

- Note:**
1. When applying coating such as paint to the panel, the dimensions should be those after the application of coating. Lock fitting is provided as a standard item.
 2. Recommended panel thickness: 1 to 5 mm.
 3. Use an A22Z-R25 Ring when mounting to a panel with 25-mm holes.

Installation

The A22K uses the same installation method as the A22. Refer to the relevant information in the *Installation* section for the A22.

Precautions

The precautions for the A22K are the same as those for the A22. Refer to the relevant information in the *Precautions* section for the A22 and the *Technical Information for Pushbutton Switches* (Cat. No. A143).

ALL DIMENSIONS SHOWN ARE IN MILLIMETERS.

To convert millimeters into inches, multiply by 0.03937. To convert grams into ounces, multiply by 0.03527.